

SPECIFICATION



YMFG-G96128ADNSWNN

June 18, 2008
Version 1.0

CONTENTS

1.	FEATURES-----	1
2.	BLOCK DIAGRAM &APPLICATION CIRCUIT -----	1
3.	OUTLINE DIMENSIONS-----	3
4.	ABSOLUTE MAXIMUM RATING -----	4
5.	ELECTRICAL CHARACTERISTICS -----	4
6.	OPTICAL CHARACTERISTICS-----	4
7.	TIMING CHARACTERISTICS -----	6,
8.	DISPLAY CONTROL INSTRUCTION -----	8
9.	INTERFACE PIN CONNECTIONS-----	27
10.	RELIABILITY -----	29
11.	QUALITY GUARANTEE -----	30
12.	INSPECTION CRITERIA -----	30
13.	PRECAUTIONS FOR USING LCD MODULES -----	33
14.	USING LCD MODULES -----	35

1. FEATURES :

ITEM	STANDARD VALUE	UNIT
Display Type	128 *128 dots	-
LCD Type	FSTN , Transmissive,Negative	-
LCD Duty	1/128	-
Viewing Direction	6:00	
Backlight Type	TFT White backlight	-
Interface	6800 OR 8080 MPU interface	-
Driver IC	Driver IC: ST7541	-
LCD Bias	1/12 BIAS	-
Module Dimension	24.3(W) X37.3(H) X5.3MAX(T)	mm
Effective Display Area	17.26(W) X23.02(H)	mm
Dot Size	0.16(W) X 0.16(H)	mm
Dot Pitch	0.18(W) X 0.18(H)	mm

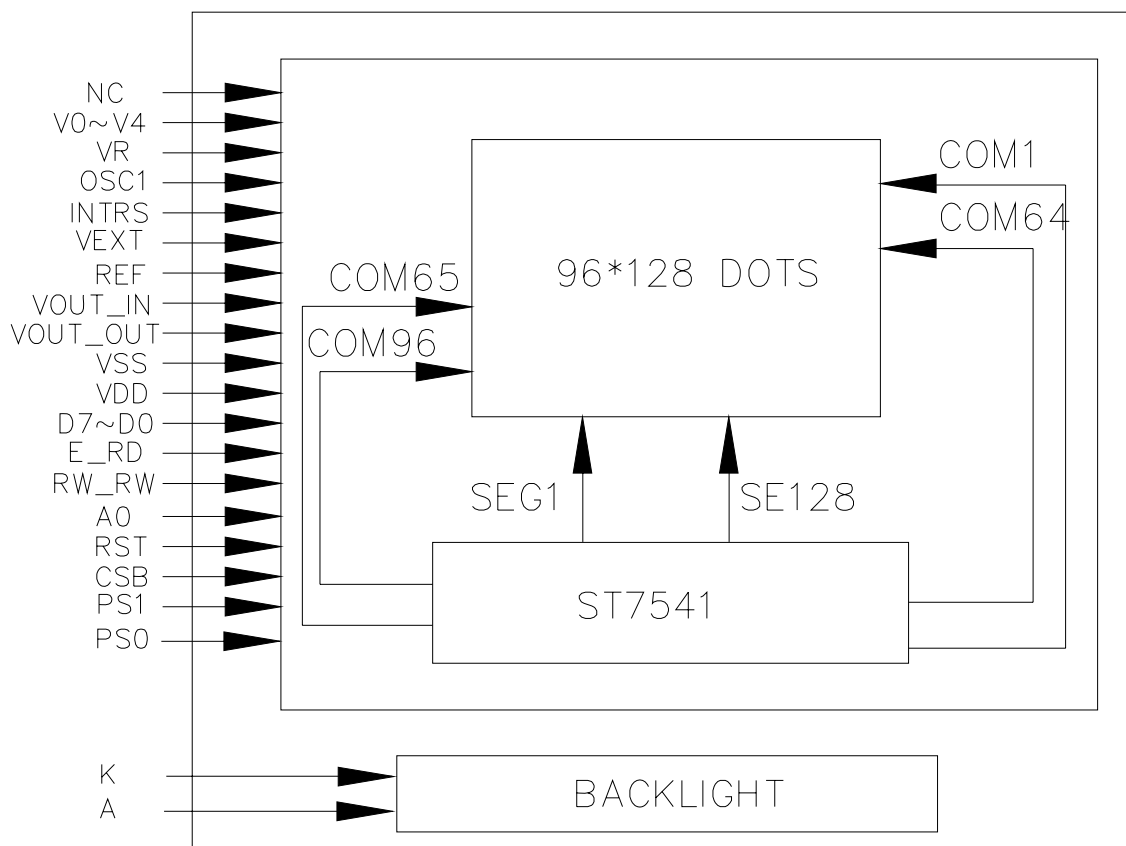
2. BLOCK DIAGRAM &APPLICATION CIRCUIT :

YM96128A

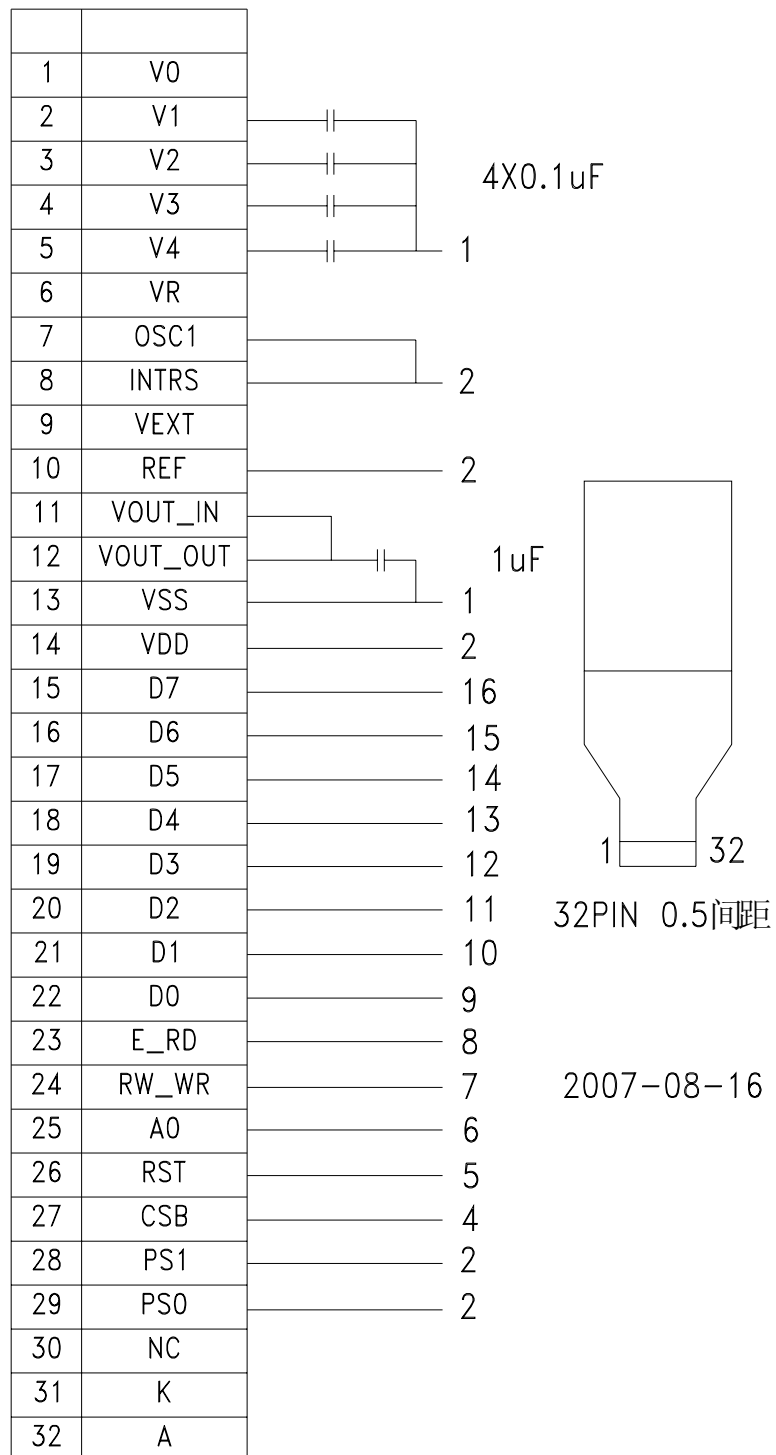

用128128G的程序测试
2007-11-30

4. ABSOLUTE MAXIMUM RATING

ITEM	SYMBOL	CONDITION	STANDARD VALUE			UNIT
			MIN	TYP	MAX	
POWER SUPPLY FOR LOGIC	VDD	Ta=25°C	-0.5	—	5.0	V
POWER SUPPLY FOR LCD DRIVING	Vlcd	Ta=25°C	-0.5	---	+15	
INPUT VOLTAGE	VIN	Ta=25°C	-0.3	—	VDD+0.3	V
Module OPERATION TEMPERATURE	TOPR	---	0	—	+50	°C
Module STORAGE TEMPERATURE	TSTG	---	- 10	—	+60	°C
Storage Humidity	H _D	Ta < 40 °C	-		90	%RH

5. ELECTRICAL CHARACTERISTICS

ITEM	SYMBOL	CONDITION	MIN	TYP	MAX	UNIT
Supply Voltage (logic)	VDD-VSS	- Ta= +25°C	2.7	3.0	3.3	V
Supply Voltage (LCD)	VDD-V0	Ta= -20 °C Ta= +25°C Ta= +70°C	- -11.7 -	- 12.0 -	- 12.3 -	V
Input signal voltage	V-IH	-	0.8VDD	-	VDD	V
	V-IL	-	VSS	-	0.2 VDD	V
Output signal voltage	V-OH	IOH=-0.5mA	0.8VDD	-	VDD	V
	VOL	IOL=0.5mA	VSS	-	0.2VDD	V
Supply Current (logic)	IDD	VDD=3.0V	-	0.3	0.5	mA
Backlight Voltage	V-BL	-	2.9	3.0	3.1	V
Backlight Current	I-BL	-	-	-	-	mA

6. OPTICAL CHARACTERISTICS

Item	Symbol	Condition	Min	Typ	Max	Unit	Remarks	Note
Response Time	Tr	-	-	110	220	ms	-	1
	Tf	-	-	260	520	ms	-	1
Contrast Ratio	Cr	-	-	3	-	-	-	2
Viewing Angle Range	θ	Cr ≥ 2	-	-	30	deg	∅= 90	3
			-	-	30	deg	∅ = 270	3
			15	-	105	deg	∅ = 0	3
			-	-	-	deg	∅ = 180	3

Note 1. Definition of response time

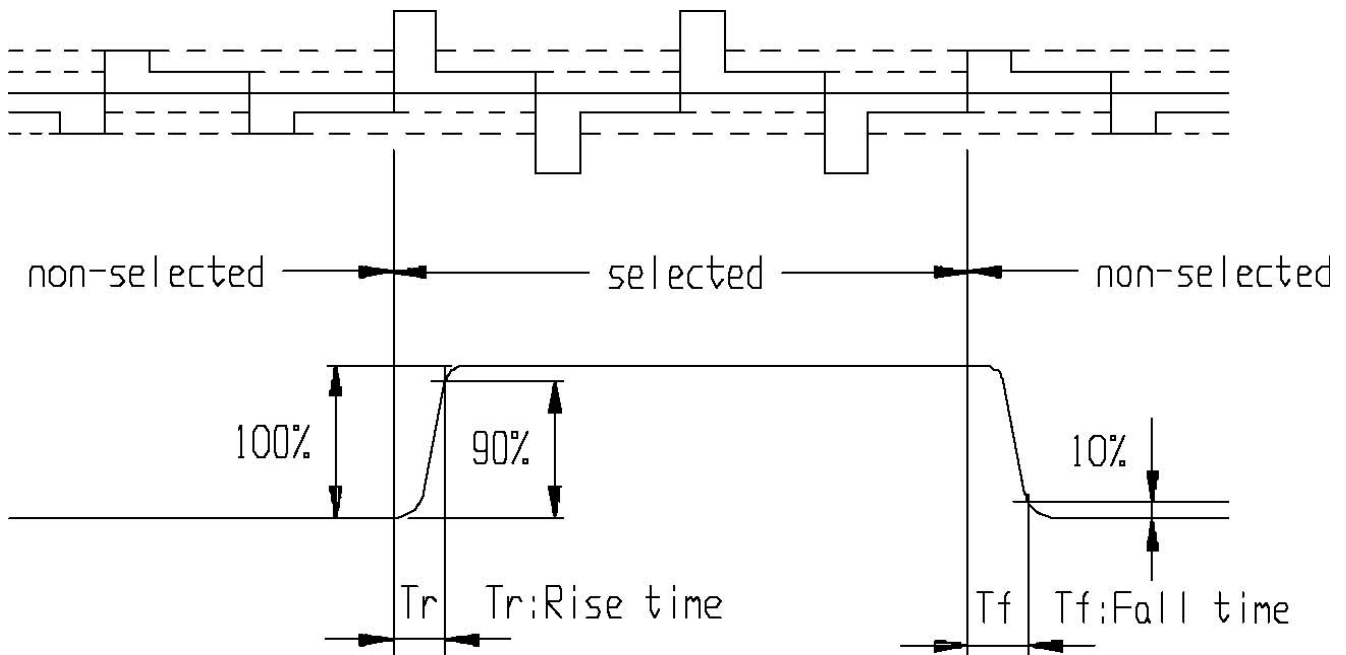

Note 2. Definition of Contrast Ratio 'Cr'

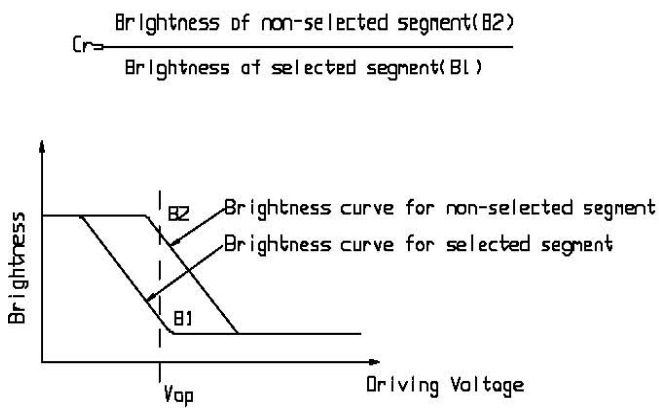

Note 3. Definition of Viewing Angle Range 'q'

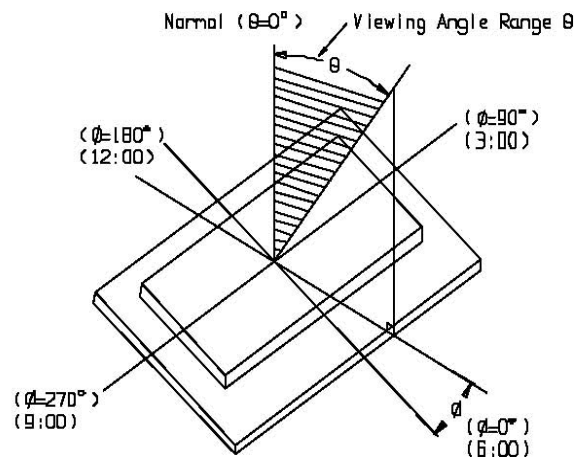

7. TIMING CHARACTERISTICS

System Bus Read/Write Characteristics 1 (For the 8080 Series MPU)

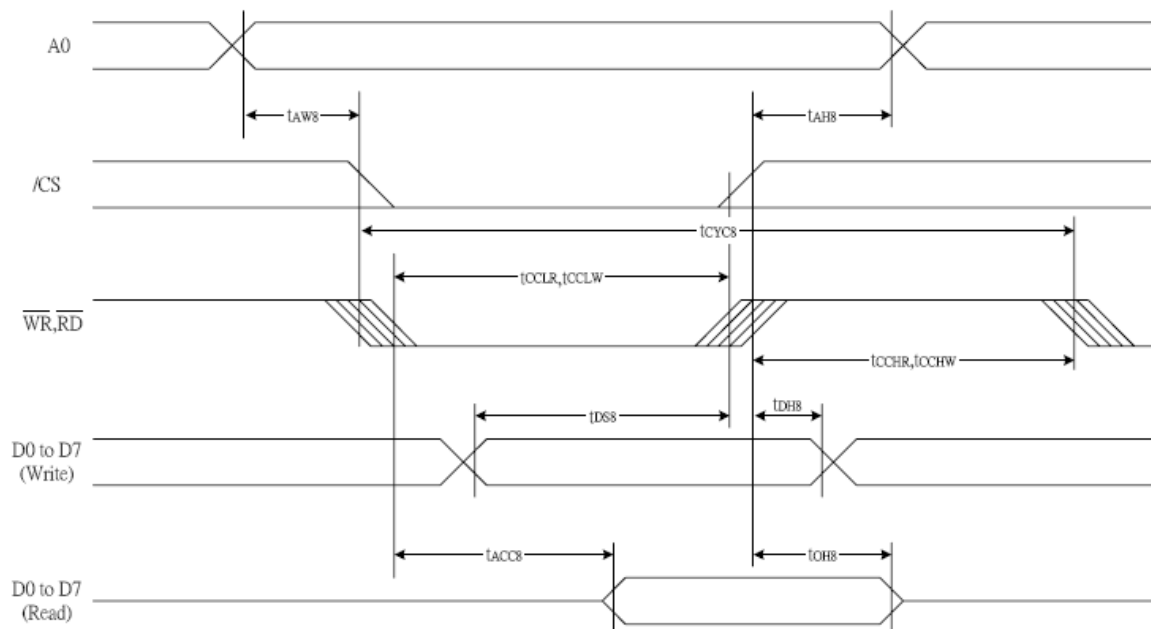

Figure 30

(VDD = 3.3V , Ta =25°C)

Item	Signal	Symbol	Condition	Rating		Units
				Min.	Max.	
Address hold time	A0	tAH8		0	—	ns
Address setup time		tAW8		0	—	
System cycle time		tCYC8		240	—	
Enable L pulse width (WRITE)	WR	tCCLW		80	—	
Enable H pulse width (WRITE)		tCCHW		80	—	
Enable L pulse width (READ)	RD	tCCLR		140	—	
Enable H pulse width (READ)		tCCHR		80	—	
WRITE Data setup time	D0 to D7	tDS8		40	—	
WRITE Data hold time		tDH8		10	—	
READ access time		tACC8	CL = 100 pF	—	70	
READ Output disable time		tOH8	CL = 100 pF	5	50	

System Bus Read/Write Characteristics 1 (For the 6800 Series MPU)

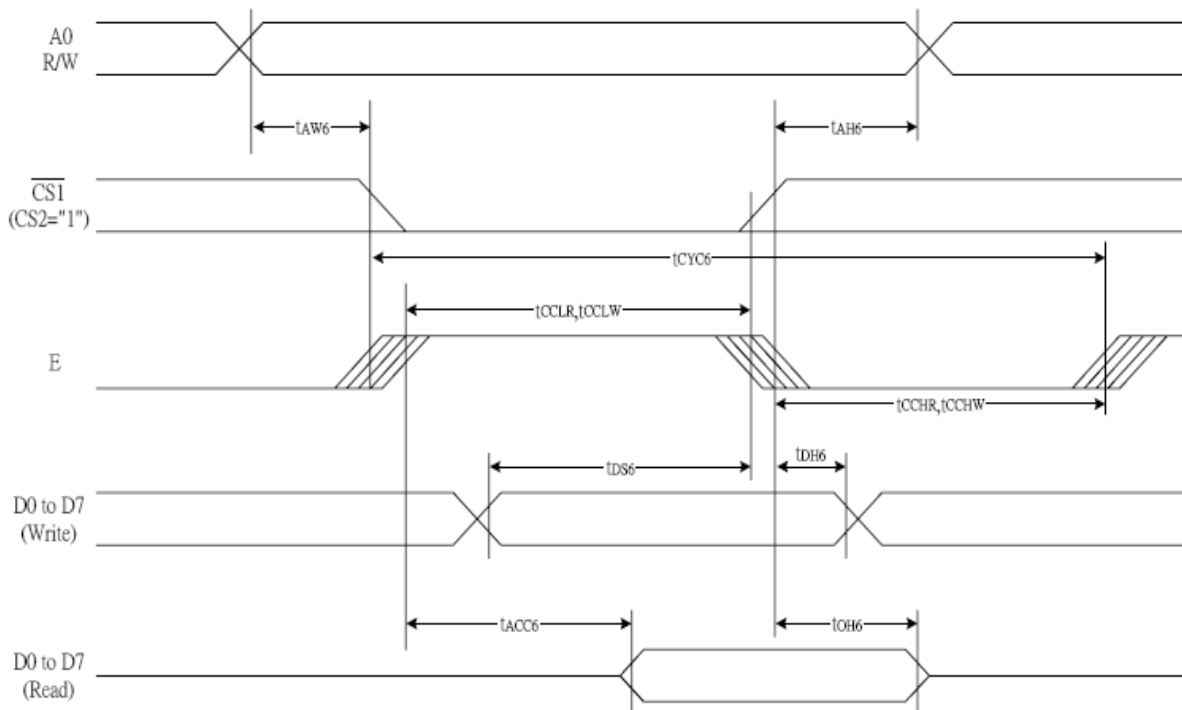

Figure 31

($V_{DD} = 3.3\text{ V}$, $T_a = 25^\circ\text{C}$)

Item	Signal	Symbol	Condition	Rating		Units
				Min.	Max.	
Address hold time	A0	tAH6		0	—	ns
Address setup time		tAW6		0	—	
System cycle time		tCYC6		240	—	
Enable L pulse width (WRITE)	WR	tEWLW		80	—	
Enable H pulse width (WRITE)		tEWHW		80	—	
Enable L pulse width (READ)	RD	tEWLR		80	—	
Enable H pulse width (READ)		tEWHR		140	—	
WRITE Data setup time	D0 to D7	tDS6		40	—	
WRITE Data hold time		tDH6		10	—	
READ access time		tACC6	CL = 100 pF	—	70	
READ Output disable time		tOH6	CL = 100 pF	5	50	

8. DISPLAY CONTROL INSTRUCTION

Instruction	A0	RW	DB7	DB6	DB5	DB4	DB3	DB2	DB1	DB0	Description
Mode Set	0	0	0	0	1	1	1	0	0	0	2-byte instruction to set Mode and FR(Frame frequency control) BE(Booster efficiency control)
	0	0	FR3	FR2	FR1	FR0	0	BE	x'	0	
Read display data	1	1	Read data								Read data into DDRAM
Write display data	1	0	Write data								Write data into DDRAM
Read status	0	1	BUSY	ON	RES	MF2	MF1	MF0	DS1	DS0	Read the internal status
ICON control register ON/OFF	0	0	1	0	1	0	0	0	1	ICON	ICON=0: ICON disable(default) ICON=1: ICON enable & set the page address to 16
Set page address	0	0	1	0	1	1	P3	P2	P1	P0	Set page address
Set column address MSB	0	0	0	0	0	1	0	Y7	Y6	Y5	Set column address MSB
Set column address LSB	0	0	0	0	0	0	Y4	Y3	Y2	Y1	Set column address LSB
Set modify-read	0	0	1	1	1	0	0	0	0	0	Set modify-read mode
Reset modify-read	0	0	1	1	1	0	1	1	1	0	release modify-read mode
Display ON/OFF	0	0	1	0	1	0	1	1	1	D	D=0: Display OFF D=1: Display ON
Set initial display line register	0	0	0	1	0	0	0	0	x'	x'	2-byte instruction to specify the initial display line to realize vertical scrolling
	0	0	x'	S6	S5	S4	S3	S2	S1	S0	
Set initial COM0 register	0	0	0	1	0	0	0	1	x'	x'	2-byte instruction to specify the initial COM0 to realize window scrolling
	0	0	x'	C6	C5	C4	C3	C2	C1	C0	
Set partial display duty ration	0	0	0	1	0	0	1	0	x'	x'	2-byte instruction to set partial display duty ratio
	0	0	D7	D6	D5	D4	D3	D2	D1	D0	
Set N-line inversion	0	0	0	1	0	0	1	1	x'	x'	2-byte instruction to set N-line inversion register
	0	0	x'	x'	x'	N4	N3	N2	N1	N0	
Release N-line inversion	0	0	1	1	1	0	0	1	0	0	Release N-line inversion mode
Reverse display ON/OFF	0	0	1	0	1	0	0	1	1	REV	REV=0: normal display REV=1: reverse display
Entire display ON/OFF	0	0	1	0	1	0	0	1	0	EON	EON=0: normal display EON=1: entire display ON

Instruction	A0	RW	DB7	DB6	DB5	DB4	DB3	DB2	DB1	DB0	Description
Power control	0	0	0	0	1	0	1	VC	VR	VF	Control power circuit operation
Select DC-DC step-up	0	0	0	1	1	0	0	1	DC1	DC0	Select the step-up of internal voltage converter
Select regulator register	0	0	0	0	1	0	0	R2	R1	R0	Select the internal resistance ratio of the regulator resistor
Select electronic volume register	0	0	1	0	0	0	0	0	0	1	2-byte instruction to specify the reference voltage
	0	0	x'	x'	EV5	EV4	EV3	EV2	EV1	EV0	
Select LCD bias	0	0	0	1	0	1	0	B2	B1	B0	Select LCD bias
Bias Power Save	0	0	1	1	1	1	0	0	1	1	Bias Power save
	0	0	0	0	0	0	0	0	0	0	Save the Bias current consumption
Release Bias Power Save Mode	0	0	1	1	1	1	0	0	1	1	Bias Power save release set the Bias power to normal
	0	0	0	0	0	0	0	1	0	0	
SHL select	0	0	1	1	0	0	SHL	x'	x'	x'	COM bi-directional selection SHL=0: normal direction SHL=1: reverse direction
ADC select	0	0	1	0	1	0	0	0	0	ADC	SEG bi-direction selection ADC=0: normal direction ADC=1: reverse direction
Oscillator on start	0	0	1	0	1	0	1	0	1	1	Start the built-in oscillator
Set power save mode	0	0	1	0	1	0	1	0	0	P	P=0: normal mode P=1: sleep mode
Release power save mode	0	0	1	1	1	0	0	0	0	1	release power save mode
Reset	0	0	1	1	1	0	0	0	1	0	initial the internal function
Set data direction & display data length(DDL)	x'	x'	1	1	1	0	1	0	0	0	2-byte instruction to specify the number of data bytes. (SPI mode)
	x'	x'	D7	D6	D5	D4	D3	D2	D1	D0	
Select FRC and PWM mode	0	0	1	0	0	1	0	FRC	PWM1	PWM0	FRC(1:3FRC, 0:4FRC) PWM1 PWM0 0 0 9PWM 0 1 9PWM 1 0 12PWM 1 1 15PWM
NOP	0	0	1	1	1	0	0	0	1	1	<i>No operation</i>
Test Instruction	0	0	1	1	1	1	x'	x'	x'	x'	<i>Don't use this instruction</i>

Instruction	A0	RW	DB7	DB6	DB5	DB4	DB3	DB2	DB1	DB0	Description
Set white mode and 1 st /2 nd frame, set pulse width	0	0	1	0	0	0	1	0	0	0	Set white mode and 1 st /2 nd frame
	0	0	WB3	WB2	WB1	WB0	WA3	WA2	WA1	WA0	
Set white mode and 3 rd /4 th frame, set pulse width	0	0	1	0	0	0	1	0	0	1	Set white mode and 3 rd /4 th frame
	0	0	WD3	WD2	WD1	WD0	WC3	WC2	WC1	WC0	
Set light gray mode and 1 st /2 nd frame, set pulse width	0	0	1	0	0	0	1	0	1	0	Set light gray mode and 1 st /2 nd frame
	0	0	LB3	LB2	LB1	LB0	LA3	LA2	LA1	LA0	
Set light gray mode and 3 rd /4 th frame, set pulse width	0	0	1	0	0	0	1	0	1	1	Set light gray mode and 3 rd /4 th frame
	0	0	LD3	LD2	LD1	LD0	LC3	LC2	LC1	LC0	
Set dark gray mode and 1 st /2 nd frame, set pulse width	0	0	1	0	0	0	1	1	0	0	Set dark gray mode and 1 st /2 nd frame
	0	0	DB3	DB2	DB1	DB0	DA3	DA2	DA1	DA0	
Set dark gray mode and 3 rd /4 th frame, set pulse width	0	0	1	0	0	0	1	1	0	1	Set dark gray mode and 3 rd /4 th frame
	0	0	DD3	DD2	DD1	DD0	DC3	DC2	DC1	DC0	
Set dark mode and 1 st /2 nd frame, set pulse width	0	0	1	0	0	0	1	1	1	0	Set dark mode and 1 st /2 nd frame
	0	0	BB3	BB2	BB1	BB0	BA3	BA2	BA1	BA0	
Set dark mode and 3 rd /4 th frame, set pulse width	0	0	1	0	0	0	1	1	1	1	Set white mode and 3 rd /4 th frame
	0	0	BB3	BD2	BD1	BD0	BC3	BC2	BC1	BC0	

Set Mode Register

2-byte instruction to set FR (Frame frequency control) and BE (Booster efficiency control)

The 1st Instruction

A0	RW	DB7	DB6	DB5	DB4	DB3	DB2	DB1	DB0
0	0	0	0	1	1	1	0	0	0

The 2nd Instruction

A0	RW	DB7	DB6	DB5	DB4	DB3	DB2	DB1	DB0
0	0	FR3	FR2	FR1	FR0	0	BE	x'	0

Frame frequency

This command is used to set the frame frequency.

FR ₃	FR ₂	FR ₁	FR ₀	FR frequency
0	0	0	0	77 Hz $\pm 5\%$
0	0	0	1	51 Hz $\pm 20\%$
0	0	1	0	55 Hz $\pm 20\%$
0	0	1	1	58 Hz $\pm 20\%$
0	1	0	0	63 Hz $\pm 20\%$
0	1	0	1	67 Hz $\pm 20\%$
0	1	1	0	68 Hz $\pm 20\%$
0	1	1	1	70 Hz $\pm 20\%$
1	0	0	0	73 Hz $\pm 20\%$
1	0	0	1	75 Hz $\pm 20\%$
1	0	1	0	80 Hz $\pm 20\%$
1	0	1	1	85 Hz $\pm 20\%$
1	1	0	0	91 Hz $\pm 20\%$
1	1	0	1	102 Hz $\pm 20\%$
1	1	1	0	113 Hz $\pm 20\%$
1	1	1	1	123 Hz $\pm 20\%$

Booster Efficiency

The ST7541 incorporates software configurable Booster Efficiency Command. It could be used with Voltage multiplier to get the suitable Vout and Power consumption. Default setting is Level 2.

Flag	Description	
BE	0	Booster Efficiency Level 1
	1	Booster Efficiency Level 2

Read Display Data

8-bit data from Display Data RAM specified by the column address and page address can be read by this instruction. As the column address is increased by 1 automatically after each this instruction, the microprocessor can continuously read data from the addressed page. A dummy read is required after loading an address into the column address register. Display Data cannot be read through the serial interface.

A0	RW	DB7	DB6	DB5	DB4	DB3	DB2	DB1	DB0
1	1	Read data							

Write Display Data

8-bit data of Display Data from the microprocessor can be written to the RAM location specified by the column address and page address. The column address is increased by 1 automatically so that the microprocessor can continuously write data to the addressed page. During auto-increment, the column address wraps to 0 after the last column is written.

A0	RW	DB7	DB6	DB5	DB4	DB3	DB2	DB1	DB0
1	1	Write data							

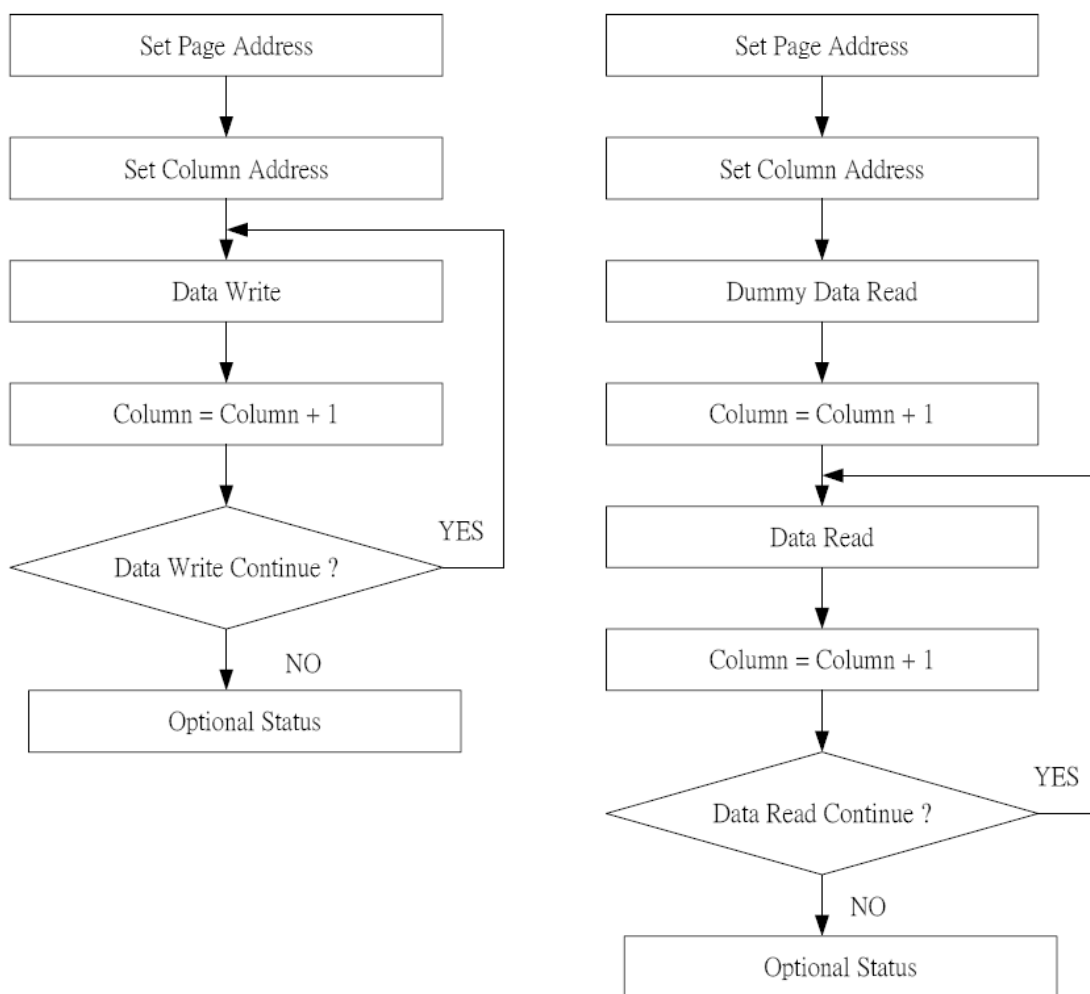

Figure 18 Sequence for Writing Display Data (Left) and Sequence for Reading Display Data (Right)

Read Status

Indicates the internal status of the ST7541

A0	RW	DB7	DB6	DB5	DB4	DB3	DB2	DB1	DB0
0	1	BUSY	ON/OFF	RES	MF2	MF1	MF0	DS1	DS0

Flag	Description
BUSY	The device is busy when internal operation or reset. Any instruction is rejected until BUSY goes Low. 0: chip is active, 1: chip is being busy
ON	Indicates display ON / OFF status 0: display OFF, 1: display ON
RESET	Indicates the initialization is in progress by RESET signal. 0: chip is active, 1: chip is being reset
MF	Manufacturer ID; recommended value: MF2 MF1 MF0 = [0 0 0] The value of MF2, MF1 and MF0 will follow the hardware selection.
DS	Display size ID; recommended value: DS1 DS0 = [1 0] The value of DS1 and DS2 will follow the hardware selection.

ICON Control Register ON/OFF

This instruction makes ICON enable or disable. By default, ICON display is disabled (ICON= 0). When ICON control register is set to "1", ICON display is enabled and page address is set to "16". Then user can write data for icons. It is impossible to set the page address to "16" by Set Page Address instruction. Therefore, when writing data for icons, ICON control register ON instruction would be used to set the page address to "16". When ICON control register is set to "0", ICON display is disabled.

A0	RW	DB7	DB6	DB5	DB4	DB3	DB2	DB1	DB0
0	0	1	0	1	0	0	0	1	ICON

ICON=0: ICON disable (default)

ICON=1: ICON enable & set the page address to 16

Set Page Address

Sets the Page Address of display data RAM from the microprocessor into the page address register. Any RAM data bit can be accessed when its Page Address and column address are specified. Along with the column address, the Page Address defines the address of the display RAM to write or read display data. Changing the Page Address doesn't affect the display status. Set Page Address instruction can not be used to set the page address to "16". Use ICON control register ON/OFF instruction to set the page address to "16".

A0	RW	DB7	DB6	DB5	DB4	DB3	DB2	DB1	DB0
0	0	1	0	1	1	P3	P2	P1	P0

P3	P2	P1	P0	Page
0	0	0	0	0
0	0	0	1	1
:	:	:	:	:
1	1	1	0	14
1	1	1	1	15

Set Column Address

Sets the Column Address of display RAM from the microprocessor into the column address register. Along with the Column Address, the Column Address defines the address of the display RAM to write or read display data.

When the microprocessor reads or writes display data to or from display RAM, Column Addresses are automatically increased.

Set Column Address MSB

A0	RW	DB7	DB6	DB5	DB4	DB3	DB2	DB1	DB0
0	0	0	0	0	1	0	Y7	Y6	Y5

Set Column Address LSB

A0	RW	DB7	DB6	DB5	DB4	DB3	DB2	DB1	DB0
0	0	0	0	0	0	Y4	Y3	Y2	Y1

Y8	Y7	Y6	Y5	Y4	Y3	Y2	Column address [Y7:Y1]
0	0	0	0	0	0	0	0
0	0	0	0	0	0	1	1
:	:	:	:	:	:	:	:
1	1	1	1	1	1	0	126
1	1	1	1	1	1	1	127

Set Modify-Read

This instruction stops the automatic increment of the column address by the read display data instruction, but the column address is still increased by the write display data instruction. And it reduces the load of microprocessor when the data of a specific area is repeatedly changed during cursor blinking or others. This mode is canceled by the reset Modify-Read instruction.

A0	RW	DB7	DB6	DB5	DB4	DB3	DB2	DB1	DB0
0	0	1	1	1	0	0	0	0	0

Reset Modify-Read

This instruction cancels the Modify-Read mode, and makes the column address return to its initial value just before the set Modify-Read instruction is started.

A0	RW	DB7	DB6	DB5	DB4	DB3	DB2	DB1	DB0
0	0	1	1	1	0	1	1	1	0

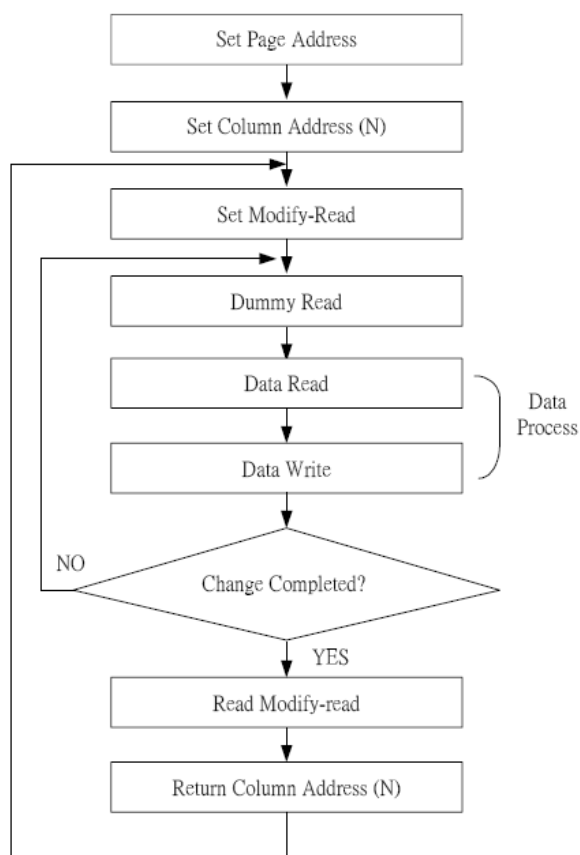

Figure 19 Sequence for Cursor Display

Display ON / OFF

Turns the display ON or OFF.

This command has priority over Entire Display On/Off and Reverse Display On/Off. Commands are accepted while the display is off, but the visual state of the display does not change.

A0	RW	DB7	DB6	DB5	DB4	DB3	DB2	DB1	DB0
0	0	1	0	1	0	1	1	1	DON

DON = 1: display ON

DON = 0: display OFF

Set Initial Display Line Register

Sets the line address of display RAM to determine the initial display line using 2-byte instruction. The RAM display data is displayed at the top of row(COM0) of LCD panel.

The 1st Instruction

A0	RW	DB7	DB6	DB5	DB4	DB3	DB2	DB1	DB0
0	0	0	1	0	0	0	0	x	x

The 2nd Instruction

A0	RW	DB7	DB6	DB5	DB4	DB3	DB2	DB1	DB0
0	0	x	S6	S5	S4	S3	S2	S1	S0
S6	S5	S4	S3	S2	S1	S0	Line address		
0	0	0	0	0	0	0	0		
0	0	0	0	0	0	1	1		
0	0	0	0	0	1	0	2		
0	0	0	0	0	1	1	3		
:	:	:	:	:	:	:	:		
1	1	1	1	1	0	0	124		
1	1	1	1	1	0	1	125		
1	1	1	1	1	1	0	126		
1	1	1	1	1	1	1	127		

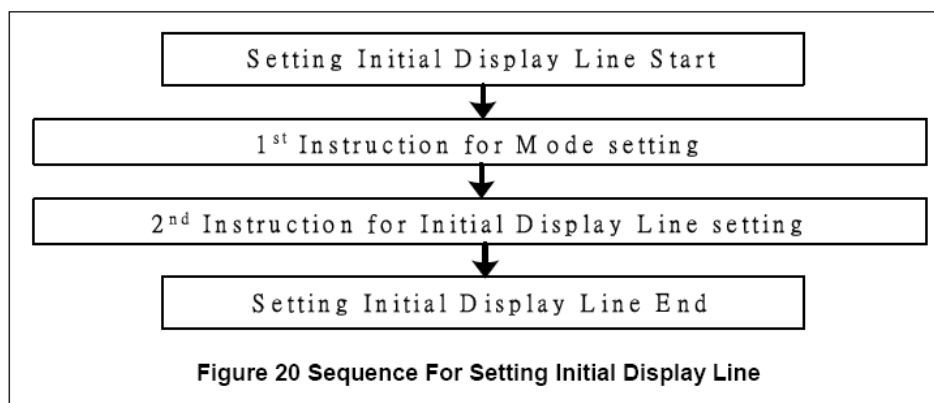
Set Initial COM0 Register

Sets the initial row (COM) of the LCD panel using the 2-byte instruction. By using this instruction, it is possible to realize the window moving without the change of display data.

The 1st Instruction

A0	RW	DB7	DB6	DB5	DB4	DB3	DB2	DB1	DB0
0	0	0	1	0	0	0	1	x	x

The 2nd Instruction

A0	RW	DB7	DB6	DB5	DB4	DB3	DB2	DB1	DB0
0	0	x	C6	C5	C4	C3	C2	C1	C0

C6	C5	C4	C3	C2	C1	C0	Initial COM0
0	0	0	0	0	0	0	COM0
0	0	0	0	0	0	1	COM1
0	0	0	0	0	1	0	COM2
0	0	0	0	0	1	1	COM3
:	:	:	:	:	:	:	:
1	1	1	1	1	0	0	COM124
1	1	1	1	1	0	1	COM125
1	1	1	1	1	1	0	COM126
1	1	1	1	1	1	1	COM127

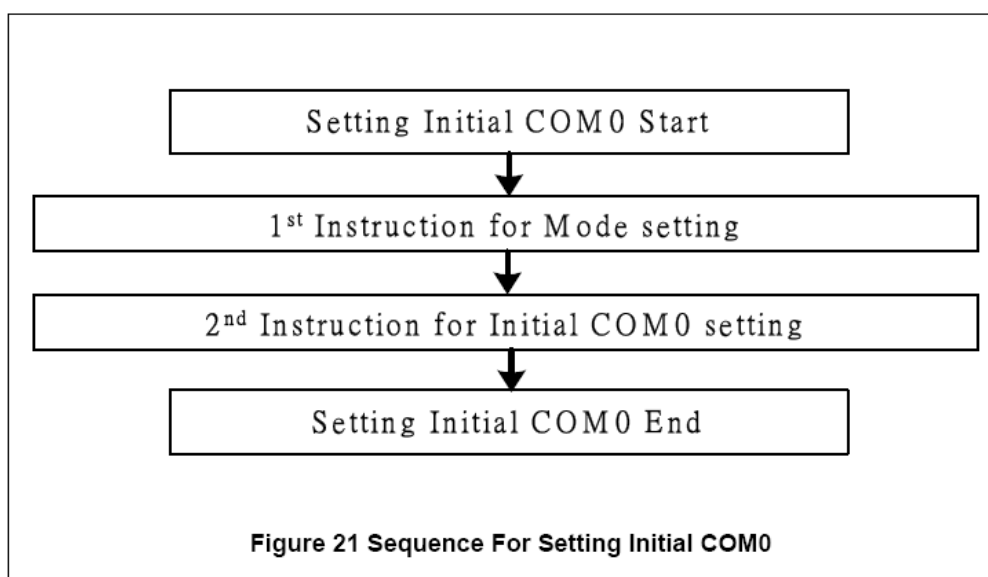

Set Partial Display Duty Ratio

Sets the duty ratio within range of 16 to 128 (ICON disabled) or 17 to 129 (ICON enabled) to realize partial display by using the 2-byte instruction.

The 1st Instruction

A0	RW	DB7	DB6	DB5	DB4	DB3	DB2	DB1	DB0
0	0	0	1	0	0	1	0	x	x

The 2nd Instruction

A0	RW	DB7	DB6	DB5	DB4	DB3	DB2	DB1	DB0
0	0	D7	D6	D5	D4	D3	D2	D1	D0

D7	D6	D5	D4	D3	D2	D1	D0	Selected partial duty ratio (ICON disabled)	Selected partial duty ratio (ICON enabled)
0	0	0	0	0	0	0	0	No operation	No operation
:	:	:	:	:	:	:	:		
0	0	0	0	1	1	1	1		
0	0	0	1	0	0	0	0	1/16	1/17
0	0	0	1	0	0	0	1	1/17	1/18
:	:	:	:	:	:	:	:	:	:
0	1	1	0	0	1	0	0	1/100	1/101
:	:	:	:	:	:	:	:	:	:
0	1	1	1	1	1	1	1	1/127	1/128
1	0	0	0	0	0	0	0	1/128	1/129
1	0	0	0	0	0	0	1	No Operation	No Operation
:	:	:	:	:	:	:	:		
1	1	1	1	1	1	1	1		

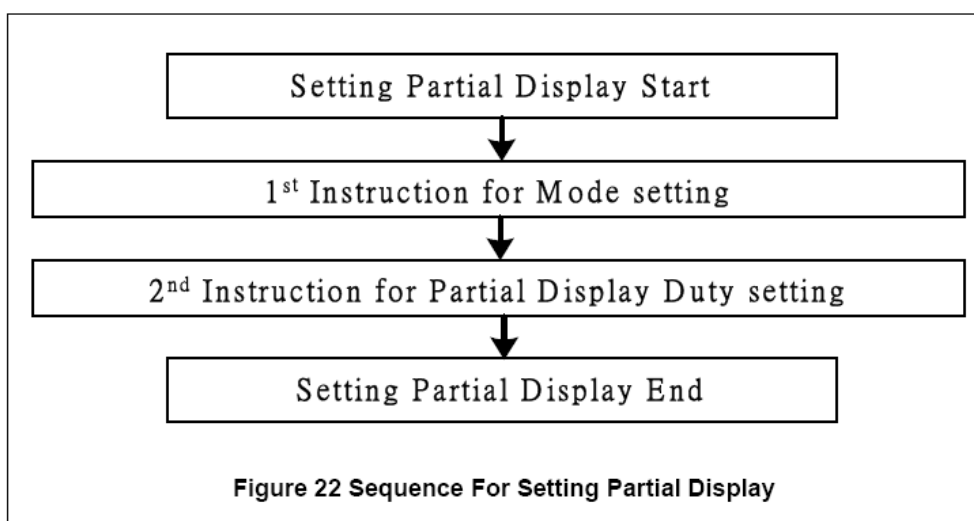

Set N-line Inversion Register

Sets the inverted line number within range of 3 to 33 to improve the display quality by controlling the phase of the internal LCD AC signal (M) by using the 2-byte instruction.

The DC-bias problem could be occurred if K is even number. So, we recommend customers to set K to be odd number. K : D/N

D: The number of display duty ratio (D is selectable by customers)

N: N for N-line inversion (N is selectable by customers).

The 1st Instruction

A0	RW	DB7	DB6	DB5	DB4	DB3	DB2	DB1	DB0
0	0	0	1	0	0	1	1	x	x

The 2nd Instruction

A0	RW	DB7	DB6	DB5	DB4	DB3	DB2	DB1	DB0
0	0	x	x	x	0	0	0	0	0

N4	N3	N2	N1	N0	Selected n-line inversion
0	0	0	0	0	0-line inversion (frame inversion)
0	0	0	0	1	3-line inversion
0	0	0	1	0	4-line inversion
0	0	0	1	1	5-line inversion
:	:	:	:	:	:
1	1	1	0	1	31-line inversion
1	1	1	1	0	32-line inversion
1	1	1	1	1	33-line inversion

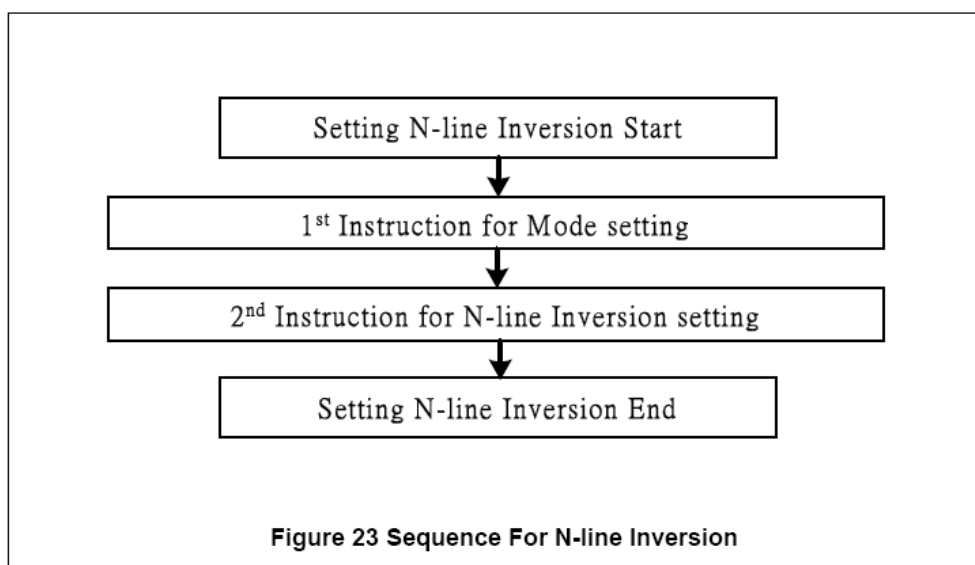
Release N-line Inversion

Returns to the frame inversion condition from the n-line inversion condition.

A0	RW	DB7	DB6	DB5	DB4	DB3	DB2	DB1	DB0
0	0	1	1	1	0	0	1	0	0

Reverse Display ON / OFF

Reverses the display status on LCD panel without rewriting the contents of the display data RAM.

A0	RW	DB7	DB6	DB5	DB4	DB3	DB2	DB1	DB0
0	0	1	0	1	0	0	1	1	REV
REV		DDRAM data = "00" – White	DDRAM data = "01" – Light gray	DDRAM data = "10" – Dark gray	DDRAM data = "11" – Dark				
0 (normal)		White ("00")	Light gray ("01")	Dark gray ("10")			Dark ("11")		
1 (reverse)		Dark ("11")	Dark gray ("10")		Light gray ("01")		White ("00")		

Entire Display ON / OFF

Forces the whole LCD points to be turned on regardless of the contents of the display data RAM. At this time, the contents of the display data RAM are held. This instruction has priority over the Reverse Display ON / OFF instruction.

A0	RW	DB7	DB6	DB5	DB4	DB3	DB2	DB1	DB0
0	0	1	0	1	0	0	1	0	EON
Entire		DDRAM data = "00" – White	DDRAM data = "01" – Light gray	DDRAM data = "10" – Dark gray			DDRAM data = "11" – Dark		
0 (normal)		White ("00")	Light gray ("01")	Dark gray ("10")			Dark ("11")		
1 (Entire)		Dark ("11")	Dark gray ("11")		Light gray ("11")		White ("11")		

Power Control

Selects one of eight power circuit functions by using 3-bit register. An external power supply and part of internal power supply functions can be used simultaneously.

A0	RW	DB7	DB6	DB5	DB4	DB3	DB2	DB1	DB0
0	0	0	0	1	0	1	VC	VR	VF

VC	VR	VF	Status of internal power supply circuits
0			Internal voltage converter circuit is OFF
1			Internal voltage converter circuit is ON
	0		Internal voltage regulator circuit is OFF
	1		Internal voltage regulator circuit is ON
		0	Internal voltage follower circuit is OFF
		1	Internal voltage follower circuit is ON

Set Bias Power Save Instruction

Consist of 2-byte Instructions

The 1st Instruction

A0	RW	DB7	DB6	DB5	DB4	DB3	DB2	DB1	DB0
0	0	1	1	1	1	0	0	1	1

The 2nd Instruction

A0	RW	DB7	DB6	DB5	DB4	DB3	DB2	DB1	DB0
0	0	0	0	0	0	0	0	0	0

This command is for saving the IC current consumption by Bias Power Saving

After this Instruction is set, Bias function is also working

Release Bias Power Save Mode

Consist of 2-byte Instructions

The 1st Instruction

A0	RW	DB7	DB6	DB5	DB4	DB3	DB2	DB1	DB0
0	0	1	1	1	1	0	0	1	1

The 2nd Instruction

A0	RW	DB7	DB6	DB5	DB4	DB3	DB2	DB1	DB0
0	0	0	0	0	0	0	1	0	0

This command is for release Bias Power Save

Select DC-DC Step-up

Selects one of 4 DC-DC step-up to reduce the power consumption by this instruction. It is very useful to realize the partial display function.

A0	RW	DB7	DB6	DB5	DB4	DB3	DB2	DB1	DB0
0	0	0	1	1	0	0	1	DC1	DC0

DC1	DC0	Selected DC-DC converter circuit
0	0	3 times boosting circuit
0	1	4 times boosting circuit
1	0	5 times boosting circuit
1	1	6 times boosting circuit

Select Regulator Resistor

Selects resistance ratio of the internal resistor used in the internal voltage regulator. See voltage regulator section in power supply circuit.

A0	RW	DB7	DB6	DB5	DB4	DB3	DB2	DB1	DB0
0	0	0	0	1	0	0	R2	R1	R0

R2	R1	R0	1+ (Rb / Ra)
0	0	0	2.3
0	0	1	3.0
0	1	0	3.7
0	1	1	4.4
1	0	0	5.1
1	0	1	5.8
1	1	0	6.5
1	1	1	7.2

Set Electronic Volume Register

Consist of 2-byte Instructions

The 1st instruction set Reference Voltage mode, the 2nd one updates the contents of reference voltage register.

After second instruction, Reference Voltage mode is released.

The 1st Instruction: Set Reference Voltage Select Mode

A0	RW	DB7	DB6	DB5	DB4	DB3	DB2	DB1	DB0
0	0	1	0	0	0	0	0	0	1

The 2nd Instruction: Set Reference Voltage Register

A0	RW	DB7	DB6	DB5	DB4	DB3	DB2	DB1	DB0
0	0	x	x	EV5	EV4	EV3	EV2	EV1	EV0

EV5	EV4	EV3	EV2	EV1	EV0	Reference voltage parameter (a)
0	0	0	0	0	0	0
0	0	0	0	0	1	1
:	:	:	:	:	:	:
:	:	:	:	:	:	:
1	1	1	1	1	0	62
1	1	1	1	1	1	63

Select LCD Bias

Selects LCD bias ratio of the voltage required for driving the LCD.

A0	RW	DB7	DB6	DB5	DB4	DB3	DB2	DB1	DB0
0	0	0	1	0	1	0	B2	B1	B0

B2	B1	B0	LCD bias
0	0	0	1/5
0	0	1	1/6
0	1	0	1/7
0	1	1	1/8
1	0	0	1/9
1	0	1	1/10
1	1	0	1/11
1	1	1	1/12

SHL Select

COM output scanning direction is selected by this instruction which determines the LCD driver output status.

A0	RW	DB7	DB6	DB5	DB4	DB3	DB2	DB1	DB0
0	0	1	1	0	0	SHL	x	x	x

SHL = 0: normal direction (COM0 → COM127)

SHL = 1: reverse direction (COM127 → COM0)

ADC Select

Changes the relationship between RAM column address and segment driver. The direction of segment driver output pins could be reversed by software. This makes IC layout flexible in LCD module assembly.

A0	RW	DB7	DB6	DB5	DB4	DB3	DB2	DB1	DB0
0	0	1	0	1	0	0	0	0	ADC

ADC = 0: normal direction (SEG0 → SEG127)

ADC = 1: reverse direction (SEG127 → SEG0)

Oscillator ON Start

This instruction enables the built-in oscillator circuit.

A0	RW	DB7	DB6	DB5	DB4	DB3	DB2	DB1	DB0
0	0	1	0	1	0	1	0	1	1

Power Save

The ST7541 enters the Power Save status to reduce the power consumption to the static power consumption value and returns to the normal operation status by the following instructions.

Set Power Save Mode

A0	RW	DB7	DB6	DB5	DB4	DB3	DB2	DB1	DB0
0	0	1	0	1	0	1	0	0	P

P = 0: normal mode , P = 1: sleep mode

Release Power Save Mode

A0	RW	DB7	DB6	DB5	DB4	DB3	DB2	DB1	DB0
0	0	1	1	1	0	0	0	0	1

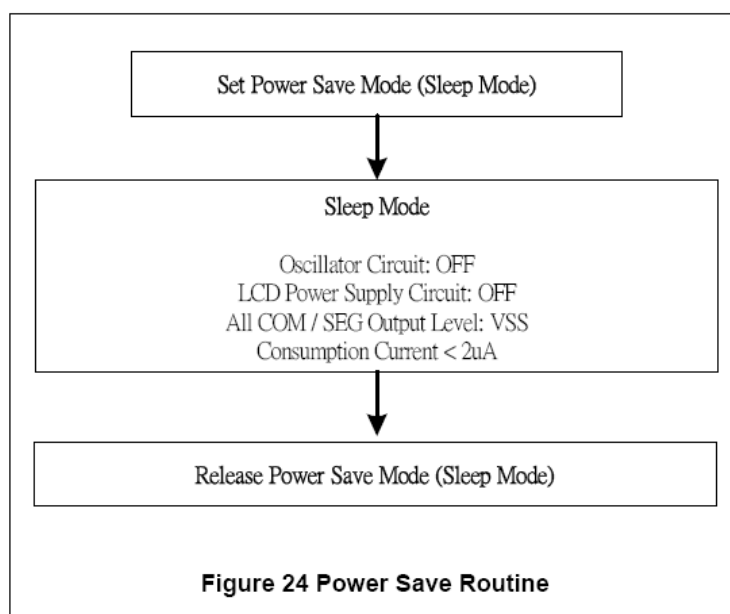
Reset

This instruction Resets initial display line, column address, page address, and common output status select to their initial status, but dose not affect the contents of display data RAM. This instruction cannot initialize the LCD power supply, which is initialized by the RESETB pin.

A0	RW	DB7	DB6	DB5	DB4	DB3	DB2	DB1	DB0
0	0	1	1	1	0	0	0	1	0

Set Data Direction & Display Data Length (3-Line SPI Mode)

Consists of 2 bytes instruction.

This command is used in 3-Line SPI mode only(PS0 = "L" and PS1 = "L"). It will be two continuous commands, the first byte control the data direction(write mode only) and inform the LCD driver the second byte will be number of data bytes will be write. When A0 is not used, the Display Data Length instruction is used to indicate that a specified number of display data bytes are to be transmitted. The next byte after the display data string is handled as command data.

The 1st Instruction: Set Data Direction (Only Write Mode)

A0	RW	DB7	DB6	DB5	DB4	DB3	DB2	DB1	DB0
x	x	1	1	1	0	1	0	0	0

The 2nd Instruction: Set Display Data Length (DDL) Register

A0	RW	DB7	DB6	DB5	DB4	DB3	DB2	DB1	DB0
x	x	D7	D6	D5	D4	D3	D2	D1	D0

D7	D6	D5	D4	D3	D2	D1	D0	Display Data Length
0	0	0	0	0	0	0	0	1
0	0	0	0	0	0	0	1	2
0	0	0	0	0	0	1	0	3
:	:	:	:	:	:	:	:	:
1	1	1	1	1	1	0	1	254
1	1	1	1	1	1	1	0	255
1	1	1	1	1	1	1	1	256

NOP

No operation

A0	RW	DB7	DB6	DB5	DB4	DB3	DB2	DB1	DB0
0	0	1	1	1	0	0	0	1	1

Test Instruction

This instruction is for testing IC. Please do not use it.

A0	RW	DB7	DB6	DB5	DB4	DB3	DB2	DB1	DB0
0	0	1	1	1	1	x	x	x	x

Set PWM & FRC mode

Selects 3/4 FRC and 9 / 12 / 15 PWM

A0	RW	DB7	DB6	DB5	DB4	DB3	DB2	DB1	DB0
0	0	1	0	0	1	0	FRC	PWM1	PWM0

FRC	PWM1	PWM0	Status of PWM & FRC
0			4FRC
1			3FRC
	0	0	9PWM
	0	1	9PWM
	1	0	12PWM
	1	1	15PWM

Set Gray Scale Mode & Register

Consists of 2 bytes instruction. The first byte sets grayscale mode and the second byte updates the contents of gray scale register without issuing any other instruction.

– Set Gray Scale Mode

A0	RW	DB7	DB6	DB5	DB4	DB3	DB2	DB1	DB0
0	0	1	0	0	0	1	GM2	GM1	GM0

GM ₂	GM ₁	GM ₀	Description
0	0	0	In case of setting whit mode and 1 st / 2 nd frame
0	0	1	In case of setting whit mode and 3 rd / 4 th frame
0	1	0	In case of setting light gray mode and 1 st / 2 nd frame
0	1	1	In case of setting light gray mode and 3 rd / 4 th frame
1	0	0	In case of setting dark gray mode and 1 st / 2 nd frame
1	0	1	In case of setting dark gray mode and 3 rd / 4 th frame
1	1	0	In case of setting dark mode and 1 st / 2 nd frame
1	1	1	In case of setting dark mode and 3 rd / 4 th frame

--Set Gray Scale Register

A0	RW	DB7	DB6	DB5	DB4	DB3	DB2	DB1	DB0
0	0	GB3	GB2	GB1	GB0	GA3	GA2	GA1	GA0
0	0	GD3	GD2	GD1	GD0	GC3	GC2	GC1	GC0

GA3, GB3, GC3, GD3	GA2, GB2, GC2, GD2	GA1, GB1, GC1, GD1	GA0, GB0, GC0, GD0	Pulse width (9 PWM)	Pulse width (12 PWM)	Pulse width (15 PWM)
0	0	0	0	0/9	0/12	0/15
0	0	0	1	1/9	1/12	1/15
:	:	:	:	:	:	:
1	0	0	1	9/9	9/12	9/15
1	0	1	0	0/9	10/12	10/15
1	0	1	0	0/9	11/12	11/15
1	1	0	0	0/9	12/12	12/15
1	1	0	1	0/9	0/12	13/15
1	1	1	0	0/9	0/12	14/15
1	1	1	1	0/9	0/12	15/15

* GA3=WA3, LA3, DA3, BA3 GA2=WA2, LA2, DA2, BA2 GA1=WA1, LA1, DA1, BA1 GA0=WA0, LA0, DA0, BA0
 GB3=WB3, LB3, DB3, BB3 GA2=WB2, LB2, DB2, BB2 GA1=WB1, LB1, DB1, BB1 GA0=WB0, LB0, DB0, BB0
 GC3=WC3, LC3, DC3, BC3 GA2=WC2, LC2, DC2, BC2 GA1=WC1, LC1, DC1, BC1 GA0=WC0, LC0, DC0, BC0
 GD3=WD3, LD3, DD3, BD3 GA2=WD2, LD2, DD2, BD2 GA1=WD1, LD1, DD1, BD1 GA0=WD0, LD0, DD0, BD0

9. INTERFACE PIN CONNECTIONS

Pin NO.	Symbol	Input/Output	Description
1~5	V0~V4	I	LCD driver supply voltages
6	VR	I	V0 Voltage adjustment pin
7	OSC1	I	External osc input,when using internal clock oscillator,connect OSC1 to VDD.
8	INTRS	I	Internal resistor select pin This pin selects the resistors for adjusting V0 Voltage level -INTRS="H":use the internal resistors. -INTRS="L":use the external resistors
9	VEXT	I	Externally input reference voltage (VREF) for the internal voltage regulator
10	REF	I	Selects the external VREF voltage via the VEXT pin -REF="H":using the internal VREF -REF="L":using the external VREF
11	VOUT_IN	SUPPLY	An external Vout supply voltage can be supplied using the VOUT_IN
12	VOUT_OUT	SUPPLY	If the internal voltage generator is used,the VOUT_IN&VOUT_OUT must be connected together.If an external supply is used this pin must be left open.
13	VSS	I	Ground
14	VDD	I	Power supply for logic +3.0V
15~22	D7~D0	I	8-bit bi-directional data bus that is connected to the standard 8-bit microprocessor data bus.

23	E_RD	I	<p>Read/Write execution control pin</p> <p>6800-series: -RW="H": When E is "H", DB0~DB7 are In an output status. -RW="L": The data on DB0~DB7 are latched at the falling edge of the E signal</p> <p>8080-series: Read enable clock input pin When /RD is "L", DB0~DB7 are in an output status.</p>
24	RW_WR	I	<p>Read/Write execution control pin</p> <p>6800-series: RW="H": read; RW="L": write</p> <p>8080-series: Write enable clock input pin</p>
25	A0	I	<p>Register select input pin</p> <p>-A0="H": DB0 to DB7 are display data -A0="L": DB0 to DB7 are control data</p>
26	RST	I	<p>Reset input pin</p> <p>When RESETB is "L", initialization is executed</p>
27	CSB	I	<p>Chip select input pins</p> <p>Data/instruction I/O is enable only when CSB is "L".</p>
28	PS1	I	<p>Microprocessor interface select input pin</p> <p>L: 8080, H: 6800</p>
29	PS0	I	<p>Parallel/Serial data input select pin</p> <p>L: Serial Mode; H: Parallel Mode</p>
30	NC	I	Not Connector
31	K	I	Cathode of backlight
32	A	I	Anode of backlight

10. RELIABILITY
Content of Reliability Test

Environmental Test				
No.	Test Item	Content of Test	Test Condition	Applicable Standard
1	High temperature storage	Endurance test applying the high storage temperature for a long time.	60 °C 200 hrs	
2	Low temperature storage	Endurance test applying the low storage temperature for a long time.	-10°C 200 hrs	
3	High temperature operation	Endurance test applying the electric stress (Voltage & Current) and the thermal stress to the element for a long time.	50 °C 200 hrs	
4	Low temperature operation	Endurance test applying the electric stress under low temperature for a long time.	-0 °C 200 hrs	
5	High temperature Humidity storage	Endurance test applying the high temperature and high humidity storage for a long time.	50 °C , 90, RH 96 hrs	MIL-202E-103B JIS-C5023
6	High temperature Humidity operation	Endurance test applying the electric stress (Voltage & Current) and temperature humidity stress to the element for a long time.	50 °C , 90, RH 96 hrs	MIL-202E-103B JIS-C5023
7	Temperature cycle	Endurance test applying the low and high temperature cycle. <div style="text-align: center;"> $0^{\circ}\text{C} \quad 25^{\circ}\text{C} \quad 50^{\circ}\text{C}$ $\xleftarrow{30\text{min.}} \quad \xrightarrow{5\text{min.}} \quad \xleftarrow{30\text{min.}}$ $\xleftrightarrow{1 \text{ cycle}}$ </div>	0°C - 50°C 10 cycles	
Mechanical Test				
8	Vibration test	Endurance test applying the vibration during transportation and using.	10-22Hz → 1.5mmp-p 22-500Hz → 1.5G Total 0.5hrs	MIL-202E-201A JIS-C5025 JIS-C7022-A-10
9	Shock test	Constructional and mechanical endurance test applying the shock during transportation.	50G half sign wave 1l msdc 3 times of each direction	MIL-202E-213B
10	Atmospheric pressure test	Endurance test applying the atmospheric pressure during transportation by air.	115 mbar 40 hrs	MIL-202E-105C
Others				
11	Static electricity test	Endurance test applying the electric stress to the terminal.	VS=800V, RS=1.5 k CS=100 pF 1 time	MIL-883B-3015.1

*** Supply voltage for logic system = 3V. Supply voltage for LCD system = Operating voltage at 25°C.

Failure Judgment Criterion

Criterion Item	Test Item No.											Failure Judgment Criterion
	1	2	3	4	5	6	7	8	9	10	11	
Basic specification												Out of the Basic Specification
Electrical characteristic												Out of the DC and AC Characteristic
Mechanical characteristic												Out of the Mechanical Specification Color change : Out of Limit Apperance Specification
Optical characteristic												Out of the Apperance Standard

11. QUALITY GUARANTEE
Acceptable Quality Level

Each lot should satisfy the quality level defined as follows.

- Inspection method : MIL-STD-105E LEVEL II Normal one time sampling
- AQL

Partition	AQL	Definition
A: Major	0.4%	Functional defective as product
B: Minor	1.5%	Satisfy all functions as product but not satisfy cosmetic standard

Definition of 'LOT'

One lot means the delivery quantity to customer at one time.

Conditions of Cosmetic Inspection
Environmental condition

The inspection should be performed at the 1cm of height from the LCD module under 2 pieces of 40W white fluorescent lamps (Normal temperature 20~25°C and normal humidity 60 ± 15%RH).

Inspection method

The visual check should be performed vertically at more than 30cm distance from the LCD panel.

Driving voltage

The VO value which the most optimal contrast can be obtained near the specified VO in the specification. (Within ± 0.5V of typical value at 25°C.).

12. INSPECTION CRITERIA
12.1 Module Cosmetic Criteria

No.	Item	Judgment Criterion	Partition
1	Difference in Spec.	None allowed	Major
2	Pattern peeling	No substrate pattern peeling and floating	Major
3	Soldering defects	No soldering missing No soldering bridge No cold soldering	Major Major Major
4	Resist flaw on substrate	Invisible copper foil ('0.5mm or more) on substrate pattern	Minor
5	Accretion of metallic Foreign matter	No soldering dust No accretion of metallic foreign matters (Not exceed '0.2mm)	Minor Minor
6	Stain	No stain to spoil cosmetic badly	Minor
7	Plate discoloring	No plate fading, rusting and discoloring	Minor
8	Solder amount	a. Soldering side of PCB Solder to form a 'Filet' all around the lead. Solder should not hide the lead form perfectly. (too much)	Minor
	1. Lead parts	b. Components side (In case of 'Through Hole PCB') Solder to reach the Components side of PCB.	
	2. Flat packages	Either 'Toe' (A) or 'Seal' (B) of the lead to be covered by 'Filet'. Lead form to be assume over solder. A B	
3. Chips		$(3/2) H \geq h \geq (1/2) H$	Minor

12.2 Screen Cosmetic Criteria (Non-Operating)

No.	Defect	Judgment Criterion	Partition
1	Spots	In accordance with <i>Screen Cosmetic Criteria (Operating) No.1.</i>	Minor
2	Lines	In accordance with <i>Screen Cosmetic Criteria (Operating) No.2.</i>	Minor
3	Bubbles in polarizer	Size : d mm	Acceptable Qty in active area
		d ≤ 0.3	Disregard
		0.3 < d ≤ 1.0	3
		1.0 < d ≤ 1.5	1
1.5 < d	0		

4	Scratch	In accordance with spots and lines operating cosmetic criteria. When the light reflects on the panel surface, the scratches are not to be remarkable.	Minor
5	Allowable density	Above defects should be separated more than 30mm each other.	Minor
6	Coloration	Not to be noticeable coloration in the viewing area of the LCD panels. Back-lit type should be judged with back-lit on state only.	Minor
7	Contamination	Not to be noticeable.	Minor

12.3. Screen Cosmetic Criteria (Operating)

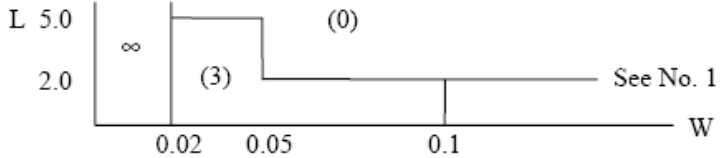
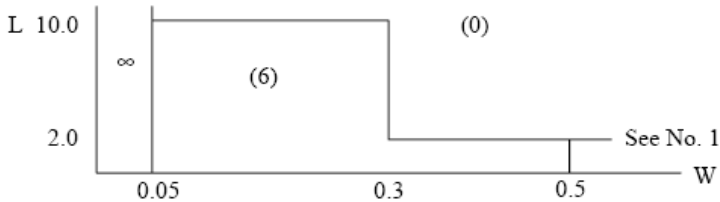
No.	Defect	Judgment Criterion	Partition																				
1	Spots	<p>A) Clear Note :</p> <table border="1"> <thead> <tr> <th>Size : d mm</th> <th>Acceptable Qty in active area</th> </tr> </thead> <tbody> <tr> <td>$d \leq 0.1$</td> <td>Disregard</td> </tr> <tr> <td>$0.1 < d \leq 0.2$</td> <td>3</td> </tr> <tr> <td>$0.2 < d \leq 0.3$</td> <td>2</td> </tr> <tr> <td>$0.3 < d$</td> <td>0</td> </tr> </tbody> </table> <p>Including pin holes and defective dots which must be within one pixel size.</p> <p>B) Unclear Size :</p> <table border="1"> <thead> <tr> <th>Size : d mm</th> <th>Acceptable Qty in active area</th> </tr> </thead> <tbody> <tr> <td>$d \leq 0.2$</td> <td>Disregard</td> </tr> <tr> <td>$0.2 < d \leq 0.5$</td> <td>6</td> </tr> <tr> <td>$0.5 < d \leq 0.7$</td> <td>2</td> </tr> <tr> <td>$0.7 < d$</td> <td>0</td> </tr> </tbody> </table>	Size : d mm	Acceptable Qty in active area	$d \leq 0.1$	Disregard	$0.1 < d \leq 0.2$	3	$0.2 < d \leq 0.3$	2	$0.3 < d$	0	Size : d mm	Acceptable Qty in active area	$d \leq 0.2$	Disregard	$0.2 < d \leq 0.5$	6	$0.5 < d \leq 0.7$	2	$0.7 < d$	0	Minor
Size : d mm	Acceptable Qty in active area																						
$d \leq 0.1$	Disregard																						
$0.1 < d \leq 0.2$	3																						
$0.2 < d \leq 0.3$	2																						
$0.3 < d$	0																						
Size : d mm	Acceptable Qty in active area																						
$d \leq 0.2$	Disregard																						
$0.2 < d \leq 0.5$	6																						
$0.5 < d \leq 0.7$	2																						
$0.7 < d$	0																						
2	Lines	<p>A) Clear</p>  <p>Note : () - Acceptable Qty in active area L -Length (mm) W - Width (mm) ∞ - Disregard</p> <p>B) Unclear</p> 	Minor																				

'Clear' = The shade and size are not changed by VO.

'Unclear' = The shade and size are changed by VO.

12.4. Screen Cosmetic Criteria (Operating) (Continued)

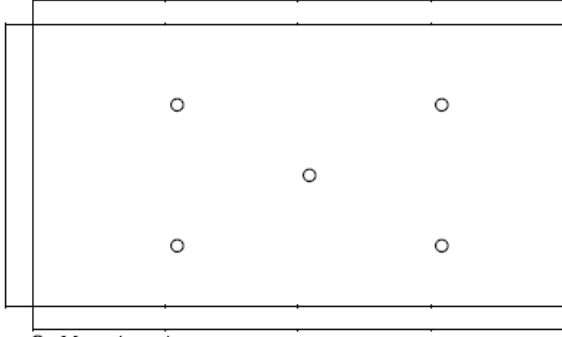
No.	Defect	Judgment Criterion	Partition
3	Rubbing line	Not to be noticeable.	
4	Allowable density	Above defects should be separated more than 10mm each other.	Minor
5	Rainbow	Not to be noticeable.	Minor
6	Dot size	To be 95% ~ 105% of the dot size (Typ.) in drawing. Partial defects of each dot (ex. pin-hole) should be treated as 'Spot'. (see <i>Screen Cosmetic Criteria (Operating) No.1</i>)	Minor
7	Uneven brightness (only back-lit type module)	Uneven brightness must be $B_{MAX} / B_{MIN} \leq 2$ - B_{MAX} : Max. value by measure in 5 points - B_{MIN} : Min. value by measure in 5 points Divide active area into 4 vertically and horizontally. Measure 5 points shown in the following figure. <div style="text-align: center;">  <p>○ : Measuring points</p> </div>	Minor

Note :

- (1) Size : $d = (\text{long length} + \text{short length}) / 2$
 - (2) The limit samples for each item have priority.
 - (3) Complexed defects are defined item by item, but if the number of defects are defined in above table, the total number should not exceed 10.
 - (4) In case of 'concentration', even the spots or the lines of 'disregarded' size should not allowed.
- Following three situations should be treated as 'concentration'.

- 7 or over defects in circle of '5mm.
- 10 or over defects in circle of '10mm.
- 20 or over defects in circle of '20mm.

13. PRECAUTIONS FOR USING LCD MODULES

Handing Precautions

- (1) The display panel is made of glass. Do not subject it to a mechanical shock by dropping it or impact.
- (2) If the display panel is damaged and the liquid crystal substance leaks out, be sure not to get any in

your mouth. If the substance contacts your skin or clothes, wash it off using soap and water.

(3) Do not apply excessive force to the display surface or the adjoining areas since this may cause the color tone to vary.

(4) The polarizer covering the display surface of the LCD module is soft and easily scratched. Handle this polarizer carefully.

(5) If the display surface becomes contaminated, breathe on the surface and gently wipe it with a soft dry cloth. If it is heavily contaminated, moisten cloth with one of the following solvents :

- Isopropyl alcohol
- Ethyl alcohol

(6) Solvents other than those above-mentioned may damage the polarizer. Especially, do not use the following.

- Water
- Ketone
- Aromatic solvents

(7) Exercise care to minimize corrosion of the electrode. Corrosion of the electrodes is accelerated by water droplets, moisture condensation or a current flow in a high-humidity environment.

(8) Install the LCD Module by using the mounting holes. When mounting the LCD module make sure it is free of twisting, warping and distortion. In particular, do not forcibly pull or bend the IO cable or the backlight cable.

(9) Do not attempt to disassemble or process the LCD module.

(10) NC terminal should be open. Do not connect anything.

(11) If the logic circuit power is off, do not apply the input signals.

(12) To prevent destruction of the elements by static electricity, be careful to maintain an optimum work environment.

- Be sure to ground the body when handling the LCD modules.
- Tools required for assembling, such as soldering irons, must be properly grounded.
- To reduce the amount of static electricity generated, do not conduct assembling and other work under dry conditions.
- The LCD module is coated with a film to protect the display surface. Exercise care when peeling off this protective film since static electricity may be generated.

Storage Precautions

When storing the LCD modules, avoid exposure to direct sunlight or to the light of fluorescent lamps. Keep the modules in bags (avoid high temperature, high humidity and low temperatures below 0°C). Whenever possible, the LCD modules should be stored in the same conditions in which they were shipped from our company.

Others

Liquid crystals solidify under low temperature (below the storage temperature range) leading to defective orientation or the generation of air bubbles (black or white). Air bubbles may also be generated if the module is subject to a low temperature.

If the LCD modules have been operating for a long time showing the same display patterns, the display patterns may remain on the screen as ghost images and a slight contrast irregularity may also appear. A

normal operating status can be regained by suspending use for some time. It should be noted that this phenomenon does not adversely affect performance reliability.

To minimize the performance degradation of the LCD modules resulting from destruction caused by static electricity etc., exercise care to avoid holding the following sections when handling the modules.

- Exposed area of the printed circuit board.
- Terminal electrode sections.

14. USING LCD MODULES

Liquid Crystal Display Modules

LCD is composed of glass and polarizer. Pay attention to the following items when handling.

- (1) Please keep the temperature within specified range for use and storage. Polarization degradation, bubble generation or polarizer peel-off may occur with high temperature and high humidity.
- (2) Do not touch, push or rub the exposed polarizers with anything harder than an HB pencil lead (glass, tweezers, etc.).
- (3) N-hexane is recommended for cleaning the adhesives used to attach front/rear polarizers and reflectors made of organic substances which will be damaged by chemicals such as acetone, toluene, ethanol and isopropylalcohol.
- (4) When the display surface becomes dusty, wipe gently with absorbent cotton or other soft material like chamois soaked in petroleum benzin. Do not scrub hard to avoid damaging the display surface.
- (5) Wipe off saliva or water drops immediately, contact with water over a long period of time may cause deformation or color fading.
- (6) Avoid contacting oil and fats.
- (7) Condensation on the surface and contact with terminals due to cold will damage, stain or dirty the polarizers. After products are tested at low temperature they must be warmed up in a container before coming is contacting with room temperature air.
- (8) Do not put or attach anything on the display area to avoid leaving marks on.
- (9) Do not touch the display with bare hands. This will stain the display area and degradate insulation between terminals (some cosmetics are determinated to the polarizers).
- (10) As glass is fragile. It tends to become or chipped during handling especially on the edges. Please avoid dropping or jarring.

Installing LCD Modules

The hole in the printed circuit board is used to fix LCM as shown in the picture below. Attend to the following items when installing the LCM.

- (1) Cover the surface with a transparent protective plate to protect the polarizer and LC cell.

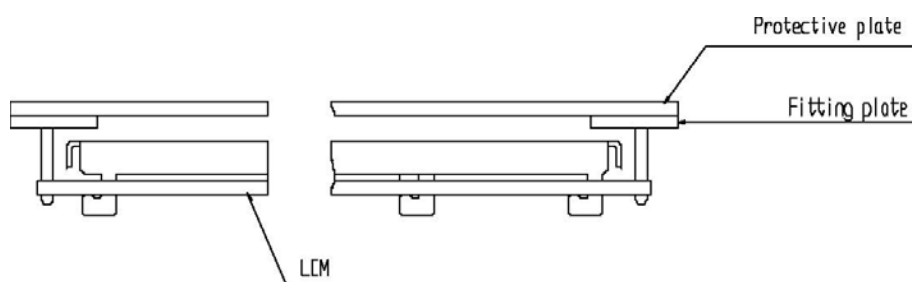

(2) When assembling the LCM into other equipment, the spacer to the bit between the LCM and the fitting plate should have enough height to avoid causing stress to the module surface, refer to the individual specifications for measurements. The measurement tolerance should be 0.1mm.

Precaution for Handling LCD Modules

Since LCM has been assembled and adjusted with a high degree of precision, avoid applying excessive shocks to the module or making any alterations or modifications to it.

- (1) Do not alter, modify or change the the shape of the tab on the metal frame.
- (2) Do not make extra holes on the printed circuit board, modify its shape or change the positions of components to be attached.
- (3) Do not damage or modify the pattern writing on the printed circuit board.
- (4) Absolutely do not modify the zebra rubber strip (conductive rubber) or heat seal connector.
- (5) Except for soldering the interface, do not make any alterations or modifications with a soldering iron.
- (6) Do not drop, bend or twist LCM.

Electro-Static Discharge Control

Since this module uses a CMOS LSI, the same careful attention should be paid to electrostatic discharge as for an ordinary CMOS IC.

- (1) Make certain that you are grounded when handling LCM.
- (2) Before remove LCM from its packing case or incorporating it into a set, be sure the module and your body have the same electric potential.
- (3) When soldering the terminal of LCM, make certain the AC power source for the soldering iron does not leak.
- (4) When using an electric screwdriver to attach LCM, the screwdriver should be of ground potentiality to minimize as much as possible any transmission of electromagnetic waves produced sparks coming from the commutator of the motor.
- (5) As far as possible make the electric potential of your work clothes and that of the work bench the ground potential.
- (6) To reduce the generation of static electricity be careful that the air in the work is not too dried. A relative humidity of 50%60% is recommended.

Precaution for soldering to the LCM

- (1) Observe the following when soldering lead wire, connector cable and etc. to the LCM.
 - Soldering iron temperature : 280°C - 10°C.
 - Soldering time : 3-4 sec.
 - Solder : eutectic solder.

If soldering flux is used, be sure to remove any remaining flux after finishing to soldering operation. (This does not apply in the case of a non-halogen type of flux.) It is recommended that you protect the LCD surface with a cover during soldering to prevent any damage dur to flux spatters.

(2) When soldering the electroluminescent panel and PC board, the panel and board should not be detached more than three times. This maximum number is determined by the temperature and time conditions mentioned above, though there may be some variance depending on the temperature of the soldering iron.

(3) When remove the electroluminescent panel from the PC board, be sure the solder has completely melted, the soldered pad on the PC board could be damaged.

Precautions for Operation

(1) Viewing angle varies with the change of liquid crystal driving voltage (VO). Adjust VO to show the best contrast.

(2) Driving the LCD in the voltage above the limit shortens its life.

(3) Response time is greatly delayed at temperature below the operating temperature range. However, this does not mean the LCD will be out of the order. It will recover when it returns to the specified temperature range.

(4) If the display area is pushed hard during operation, the display will become abnormal. However, it will return to normal if it is turned off and then back on.

(5) Condensation on terminals can cause an electrochemical reaction disrupting the terminal circuit. Therefore, it must be used under the relative condition of 40°C , 50% RH.

(6) When turning the power on, input each signal after the positive/negative voltage becomes stable.

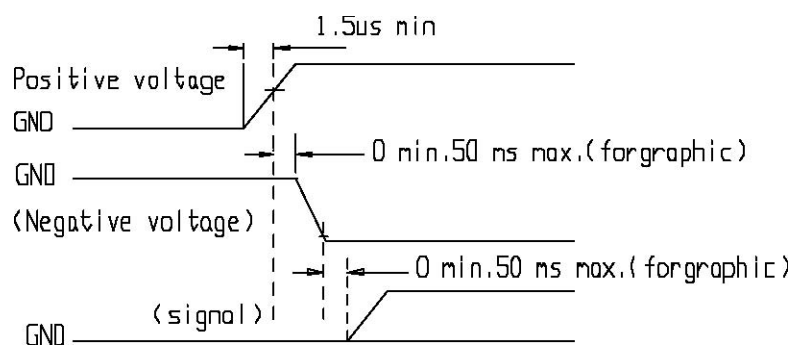

Storage

When storing LCDs as spares for some years, the following precaution are necessary.

(1) Store them in a sealed polyethylene bag. If properly sealed, there is no need for dessicant.

(2) Store them in a dark place. Do not expose to sunlight or fluorescent light, keep the temperature between 0°C and 35°C.

(3) The polarizer surface should not come in contact with any other objects. (We advise you to store them in the container in which they were shipped.)

Safety

(1) It is recommended to crush damaged or unnecessary LCDs into pieces and wash them off with solvents such as acetone and ethanol, which should later be burned.

(2) If any liquid leaks out of a damaged glass cell and comes in contact with the hands, wash off thoroughly with soap and water.

Limited Warranty

Unless agreed between YAOYU and customer, YAOYU will replace or repair any of its LCD modules which are found to be functionally defective when inspected in accordance with YAOYU LCD acceptance standards (copies available upon request) for a period of one year from date of shipments. Cosmetic/visual defects must be returned to YAOYU within 90 days of shipment. Confirmation of such date shall be based on freight documents. The warranty liability of YAOYU limited to repair and/or replacement on the terms set forth above. YAOYU will not be responsible for any subsequent or consequential events.

Return LCM under warranty

No warranty can be granted if the precautions stated above have been disregarded. The typical examples of violations are :

- Broken LCD glass.
- PCB eyelet's damaged or modified.
- PCB conductors damaged.
- Circuit modified in any way, including addition of components.
- PCB tampered with by grinding, engraving or painting varnish.
- soldering to or modifying the bezel in any manner.

Module repairs will be invoiced to the customer upon mutual agreement. Modules must be returned with sufficient description of the failures or defects. Any connectors or cable installed by the customer must be removed completely without damaging the PCB eyelet's, conductors and terminals.